

## ARCHITECTURAL SIGN SYSTEMS ARHITEKTŪRAS NORĀŽU SISTĒMAS ARCHITEKTŪRINĒS NUORODŪ SISTEMOS



Interjera Zīmju Sistēmas | Outdoor Zīmju Sistēmas | Katalogi un Displeji | Ilgtspējīgi Risinājumi | Speciālie Produkti | Norāžu Sistēmas  
Interior Sign Systems | Exterior Sign Systems | Directories & Displays | Sustainable Solutions | Specialty Products | Wayfinding

A.Deglava iela 166B, Rīga, Latvia | tālr.: +371 67800830 | +371 26596474 | e-pasts: support@wmt.lv | www.apg.uzlex.eu | www.adv24.lv

WMT Baltic | uzlex.eu projects





Our specialization is the interior design of public areas with signage systems.

For over 20 years, we have been cooperating with the leading European companies – producers. We offer modern solutions for administrative, public, office and industrial buildings.

Our company has a lot of experience in cooperation with customers from Latvia and other countries. We have our own manufacturing base in Latvia with the large warehouse of materials and developed technologies.

We offer more than 500 ready signage system solutions. Our designers have great experience in designing and layout visualization of different complexity.

Our specialization:

- signage systems from anodized aluminum – wall-mounted and freestanding;
- organic glass products of any complexity, with or without backlight;
- high-quality, thin light panels;
- information protection;
- special floor anti-slip tapes.

Our company is ready for cooperation with specialists.

Best regards,  
APG team

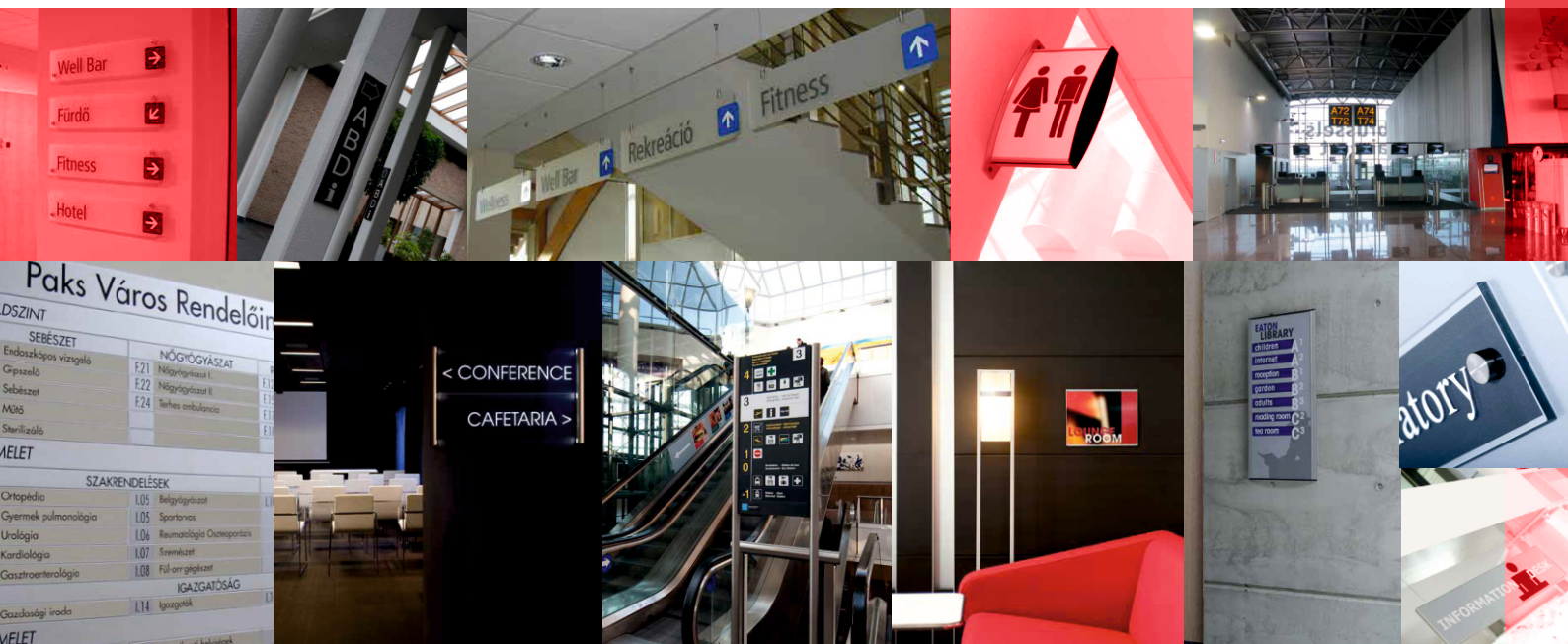

# SATURS

## 1. SIGN SYSTEMS

4

- 1.1. Modul Plus Indoor Systems
- 1.2. Rainbow Plus Systems
- 1.3. Curvo Plus
- 1.4. Acrilic Set
- 1.5. I-Sign Fix, I-Sign Flex

5  
9  
11  
12  
12

## 2. CLICK PROFILE SOLUTIONS

15

- 2.1. Click Profile Frames
- 2.2. Poster Mounting Systems
- 2.3. Banner Mounting Systems
- 2.4. Lockable Frame
- 2.5. Weatherproof Frame
- 2.6. Outdoor A Board Stand with Click Frame
- 2.7. Advertising Click Stand
- 2.8. Menuboard
- 2.9. Info Click Stand

16  
17  
17  
18  
19  
20  
21  
22  
23

## 3. LED FRAMES, TEXTILE FRAMES

24

- 3.1. Ultrathin Light LED Frame
- 3.2. Light LED Frame
- 3.3. Large Magnetic Frame
- 3.4. Soled
- 3.5. LED Thinlite
- 3.6. Textile Tension Frames
- 3.7. Light Tex Box

25  
26  
27  
28  
29  
30  
31

## 4. OUTDOOR SOLUTIONS

32

- 4.1. Windows Box System
- 4.2. Advertising Construction with Lightning
- 4.3. Pylon systems
- 4.4. Module Plus Outdoor

33  
34  
35  
35

### MODULE PLUS INDOOR

### MODULE PLUS INDOOR SLIDER

### RAINBOW PLUS

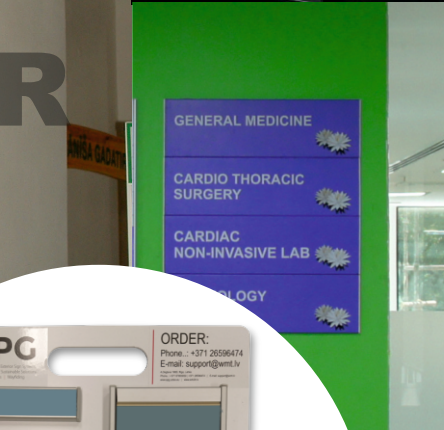

**COSIGN**  
MODULAR SIGN SYSTEMS

**DO YOU NEED A DEMONSTRATION STAND?**

CONTACT US BY PHONE,  
E-MAIL AND WE WILL  
MAKE YOU AN OFFER!



**DEMONSTRATION  
STAND**



## Module Plus Systems

1.1.

### MODUL PLUS INDOOR *Best product*

Anodized aluminum sign with plastic end caps, for wall mounting.

Art.	Product name	Size
21670501	ANO2015 silver	15*250mm
21670502	ANO2031 silver	31*250mm
21670503	ANO2046 silver	46*250mm
21670504	ANO2062 silver	62*250mm
21670505	ANO2093 silver	93*250mm
21670506	ANO4015 gold	15*250mm
21670507	ANO4031 gold	31*250mm
21670508	ANO4046 gold	46*250mm
21670509	ANO4062 gold	62*250mm
21670510	ANO4093 gold	93*250mm

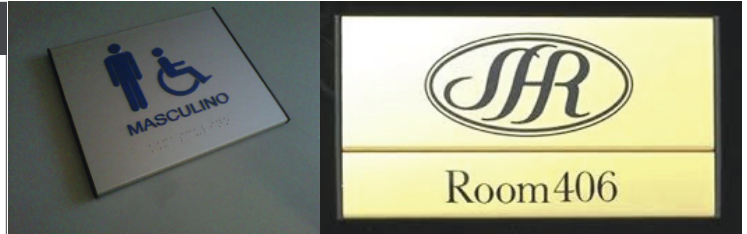

Colours:



### MODUL PLUS INDOOR DOUBLE *Best product*

Double-sided sign of anodized aluminum with plastic end caps, for ceiling mounting.

Art.	Product name	Size
21670531	ANO2187 silver	187*300mm
21670532	ANO2187 silver	187*500mm
21670533	ANO2187 silver	187*1000mm
21670534	ANO4187 gold	187*300mm
21670535	ANO4187 gold	187*500mm
21670536	ANO4187 gold	187*1000mm

Colours:

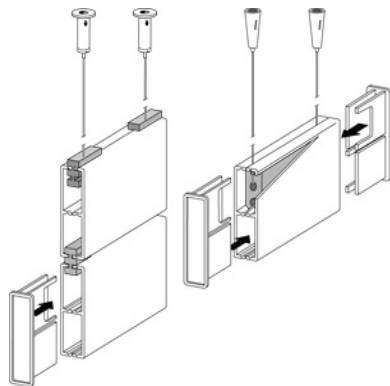
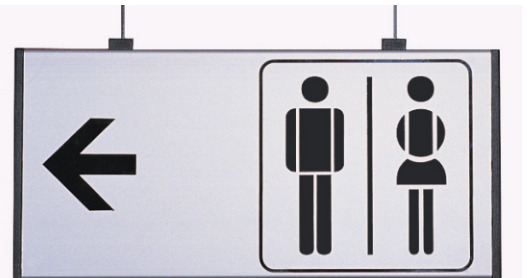

### MODULE PLUS INDOOR SLIDER *Best product*

Anodized aluminum sign with plastic end caps and anti-glare cover, for wall mounting. The best solution for frequent and quick information change.

Art.	Product name	Size
21670511	ASO2015 silver	15*250mm
21670512	ASO2031 silver	31*250mm
21670513	ASO2046 silver	46*250mm
21670514	ASO2062 silver	62*250mm
21670515	ASO2093 silver	93*250mm
21670516	ASO4015 gold	15*250mm
21670517	ASO4031 gold	31*250mm
21670518	ASO4046 gold	46*250mm
21670519	ASO4062 gold	62*250mm
21670520	ASO4093 gold	93*250mm



Colours:



**APG**



**Module Plus Indoor**

**ALUMINIUM FACE PANELS WITH SLIDER**

Sliding profiles for changeable inserts in aluminium S/10 or engraving materials

**SINGLE SLIDER 15,5mm**  
ASO1015 15,5mm  
Mill Finish



Also available in:  
Silver Anodised ASO2...  
Coloured ASO3...  
Gold Anodised ASO4...

**SINGLE SLIDER 31mm**  
ASO1031 31mm  
Mill Finish



Also available in:  
Silver Anodised ASO2...  
Coloured ASO3...  
Gold Anodised ASO4...

**SINGLE SLIDER 46,5mm**  
ASO1046 46,5mm  
Mill Finish

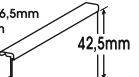

Also available in:  
Silver Anodised ASO2...  
Coloured ASO3...  
Gold Anodised ASO4...

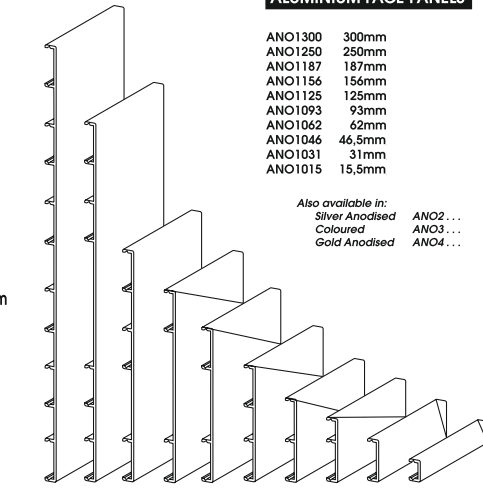

**ALUMINIUM FACE PANELS**

ANO1300	300mm
ANO1250	250mm
ANO1187	187mm
ANO1156	156mm
ANO1125	125mm
ANO1093	93mm
ANO1062	62mm
ANO1046	46,5mm
ANO1031	31mm
ANO1015	15,5mm

Also available in:  
Silver Anodised ASO2...  
Coloured ASO3...  
Gold Anodised ASO4...

300mm 250mm 187mm 156mm 125mm 93mm 62mm 46,5mm 31mm 15,5mm  
(\* Only to be used in combination with Aluminium Side Tracks and the Side Track Clip APC5001.

**SINGLE SLIDER 62mm**  
ASO1062 62mm  
Mill Finish

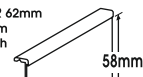

Also available in:  
Silver Anodised ASO2...  
Coloured ASO3...  
Gold Anodised ASO4...

**SINGLE SLIDER 93mm**  
ASO1093 93mm  
Mill Finish

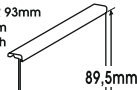

Also available in:  
Silver Anodised ASO2...  
Coloured ASO3...  
Gold Anodised ASO4...

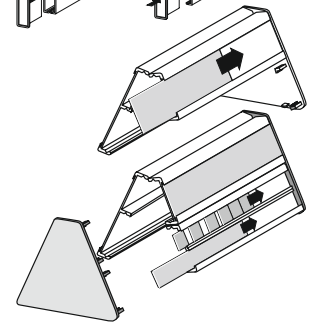
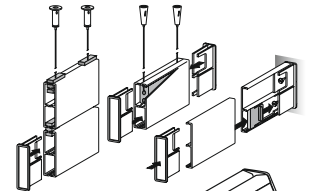
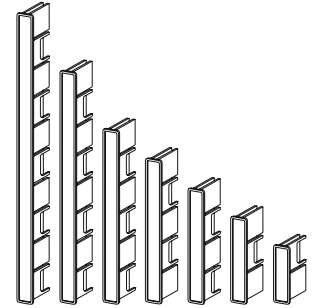
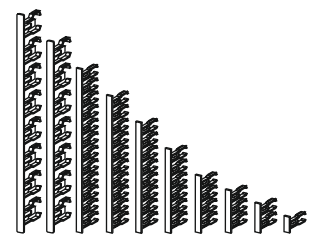
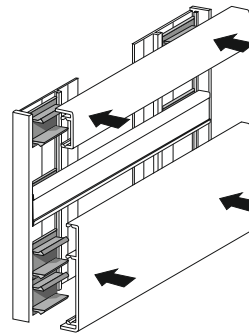
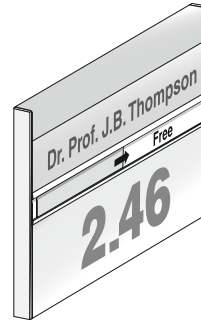
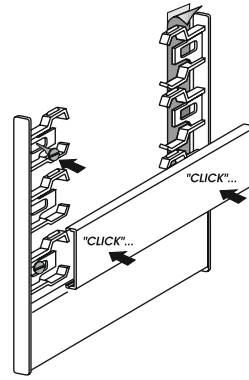

**DOUBLE SLIDER 31mm**  
ASO1031.2S 31mm  
Mill Finish

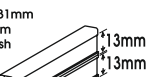

Also available in:  
Silver Anodised ASO2...  
Coloured ASO3...  
Gold Anodised ASO4...

**SINGLE SLIDER SPECIAL (SP) 31mm**  
ASO1031.SP  
Mill Finish

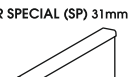

Also available in:  
Silver Anodised ASO2...  
Coloured ASO3...  
Gold Anodised ASO4...



**PLASTIC KEY**

APK1000

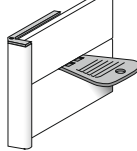

**Rainbow Plus**

INSERT	PROFILE
DIN A8	68 mm
DIN A7	92 mm
DIN A6	128 mm
DIN A5	179 mm
DIN A4	238 mm
universal edge profile for all sizes	

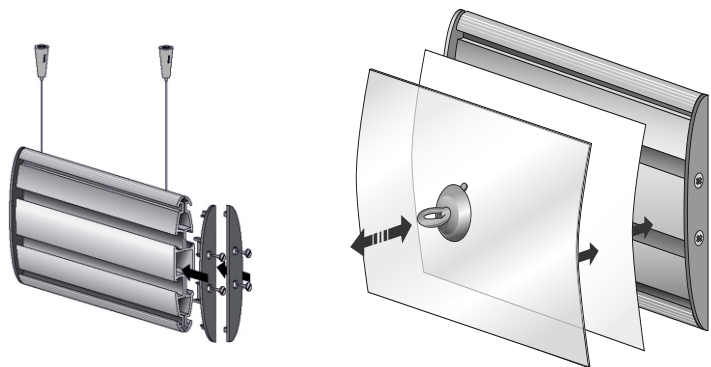









































SEND US A REQUEST AND WE WILL MAKE AN OFFER A.S.A.P.

E-mail: support@wmt.lv



PROFILE: SILVER OR GOLD

ENDCAPS: GREY OR BLACK



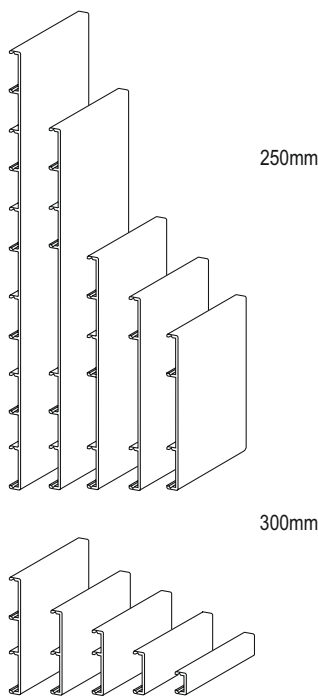

















	100mm	150mm	200mm	250mm	300mm
31mm	 ANO31100	 ANO31150	 ANO31200	 ANO31250	 ANO31300
46mm	 ANO46100	 ANO46150	 ANO46200	 ANO46250	 ANO46300
62mm	 ANO62100	 ANO62150	 ANO62200	 ANO62250	 ANO62300
93mm	 ANO93100	 ANO93150	 ANO93200	 ANO93250	 ANO93300
125mm	 ANO125100	 ANO125150	 ANO125200	 ANO125250	 ANO125300
156mm	 ANO156100	 ANO156150	 ANO156200	 ANO156250	 ANO156300
187mm	 ANO187100	 ANO187150	 ANO187200	 ANO187250	 ANO187300
			 ANO250200	 ANO250250	 ANO250300
			 ANO300200	 ANO300250	 ANO300300





PROFILE: SILVER OR GOLD

ENDCAPS: GREY OR BLACK

	100mm	150mm	200mm	250mm	300mm
31mm	 ASO31100	 ASO31150	 ASO31200	 ASO31250	 ASO31300
46mm	 ASO46100	 ASO46150	 ASO46200	 ASO46250	 ASO46300
62mm	 ASO62100	 ASO62150	 ASO62200	 ASO62250	 ASO62300
93mm	 ASO93100	 ASO93150	 ASO93200	 ASO93250	 ASO93300

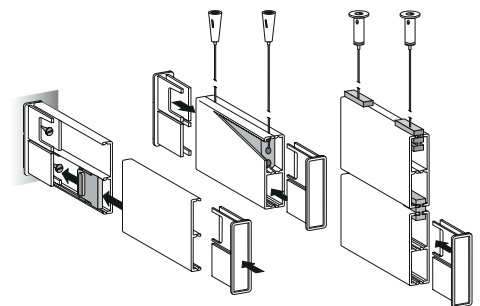
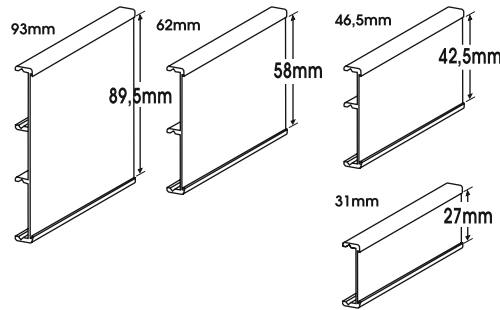



# Rainbow sign system

1.2.

## RAINBOW PROFILE *Best product*

Curved sign system of anodized aluminum profile with plastic end caps and anti-glare cover, for wall mounting.

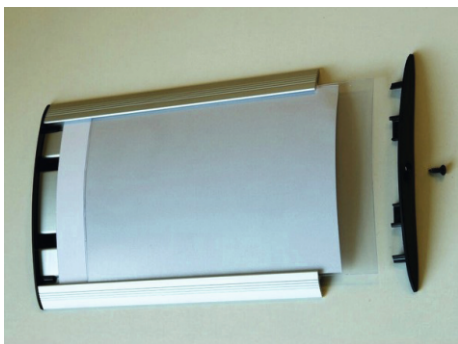

Colours:



silver matt



gold matt

Art.	Product name	Size
21670601	RAIN2068 silver	68*250mm
21670602	RAINPLUS2092 silver	92*250mm
21670603	RAINPLUS2128 silver	128*300m
21670604	RAINPLUS2179 silver	179*300mm
21670605	RAINPLUS2238 silver	238*300mm
21670615	RAIN4068 gold	68*250mm
21670616	RAINPLUS4092 gold	92*250mm
21670617	RAINPLUS4128 gold	128*300m
21670618	RAINPLUS4179 gold	179*300mm
21670619	RAINPLUS4238 gold	238*300mm

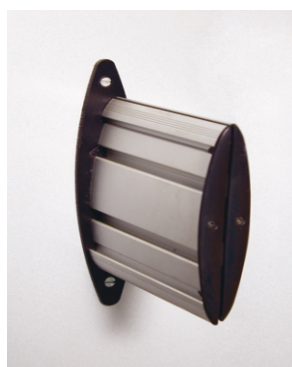
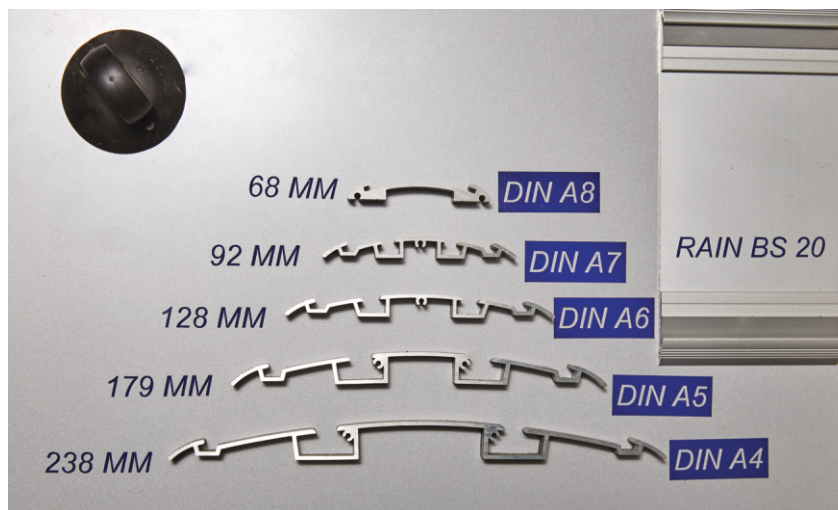



PROFILE: SILVER OR GOLD

ENDCAPS: GREY OR BLACK

	100mm	150mm	200mm	250mm	300mm
68mm	 RAIN68100	 RAIN68150	 RAIN68200	 RAIN68250	 RAIN68300
92mm	 RAIN92100	 RAIN92150	 RAIN92200	 RAIN92250	 RAIN92300
128mm	 RAIN128100	 RAIN128150	 RAIN128200	 RAIN128250	 RAIN128300
179mm	 RAIN179100	 RAIN179150	 RAIN179200	 RAIN179250	 RAIN179300
238mm	 RAIN238100	 RAIN238150	 RAIN238200	 RAIN238250	 RAIN238300

PROFILE

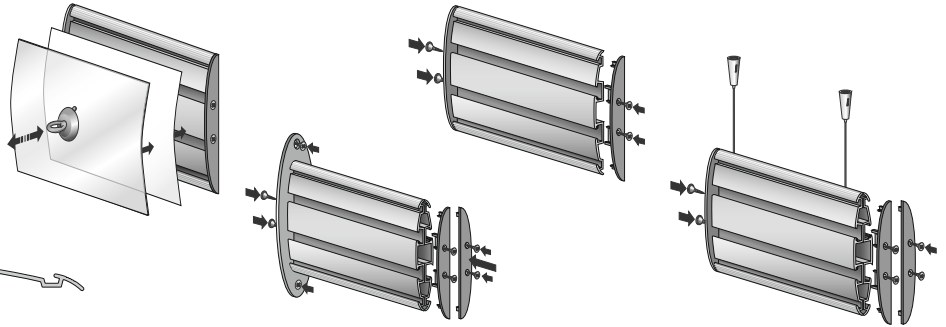
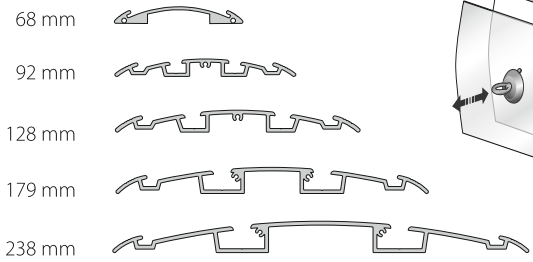

FOR NON-STANDARD SOLUTIONS - PRICE ON REQUEST

e-mail: support@wmt | phone: +371 26 596 474

1.3.

Curvo Plus is a modern, indoor sign system made from high-quality aluminium and executed in a stylish design with gently curved profiles and rounded corners.

The tabs with a stainless steel look keep the signs and the anti-reflective covers in place and give the signs extra cachet.

Moreover, the tabs are the same for all profiles.

This limits the number of components and simplifies installation. It is possible to inscribe or print directly on the profiles.

# Curvo Plus



## AVAILABLE SIZES

INSERT	PROFILE	INSERT	PROFILE	INSERT	PROFILE	INSERT	PROFILE
89 x 150mm	104mm	119 x 150mm	134mm	149 x 105mm (DIN A6)	164mm	210 x 150mm	224mm
89 x 210mm	104mm	119 x 210mm	134mm	149 x 150mm	164mm	210 x 297mm (DIN A4)	224mm
89 x 297mm	104mm	119 x 297mm	134mm	149 x 210mm (DIN A5)	164mm	297 x 210mm (DIN A4)	312mm
89 x 420mm	104mm	119 x 420mm	134mm	149 x 297mm	164mm	297 x 420mm (DIN A3)	312mm
				149 x 420mm	164mm		

1.4.

ACRYL DOUBLE SET

Article	Name	Size
21580101	Double Acryl Set	337 x 210mm
21580102	Double Acryl Set	150 x 150mm

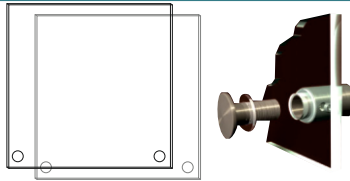

ACRYL SET

Article	Name	Size
21580110	Acryl Set	150 x 80 x 3mm
21580111	Acryl Set	150 x 80 x 5mm
21580112	Acryl Set	150 x 135 x 3mm
21580113	Acryl Set	150 x 135 x 5mm
21580114	Acryl Set	150 x 150 x 3mm
21580115	Acryl Set	150 x 150 x 5mm
21580116	Acryl Set	150 x 150 x 8mm
21580117	Acryl Set	150 x 200 x 3mm
21580118	Acryl Set	150 x 200 x 5mm
21580119	Acryl Set	150 x 200 x 8mm
21580120	Acryl Set	200 x 100 x 5mm
21580121	Acryl Set	200 x 100 x 8mm
21580122	Acryl Set	200 x 100 x 10mm
21580123	Acryl Set	200 x 200 x 5mm
21580124	Acryl Set	200 x 200 x 8mm
21580125	Acryl Set	200 x 200 x 10mm
21580126	Acryl Set	200 x 300 x 5mm
21580127	Acryl Set	200 x 300 x 8mm
21580128	Acryl Set	200 x 300 x 10mm
21580129	Acryl Set	200 x 400 x 5mm
21580130	Acryl Set	200 x 400 x 8mm
21580131	Acryl Set	200 x 400 x 10mm
21580132	Acryl Set	400 x 300 x 5mm
21580133	Acryl Set	400 x 300 x 8mm
21580134	Acryl Set	400 x 300 x 10mm
21580135	Acryl Set	400 x 400 x 5mm
21580136	Acryl Set	400 x 400 x 8mm
21580137	Acryl Set	400 x 400 x 10mm

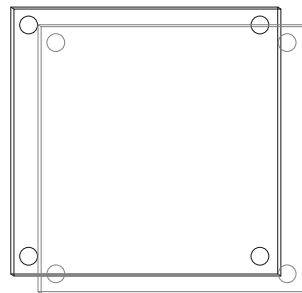
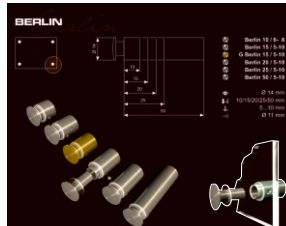

1.5.

I SIGN FIX

Article	Name	Size
21601200	IF-150150-W	150 x 150mm
21601202	IF-150300-W	150 x 300mm
21601201	IF-150600-W	150 x 600mm
21601204	IF-297210-W	297 x 210mm
21601203	IF-297420-W	297 x 420mm

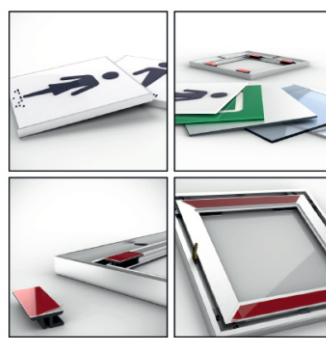

I SIGN FLEX

Article	Name	Size
21601210	I-150150-W	150 x 150mm
21601212	I-150300-W	150 x 300mm
21601211	I-150600-W	150 x 600mm
21601214	I-297210-W	297 x 210mm
21601212	I-297420-W	297 x 420mm

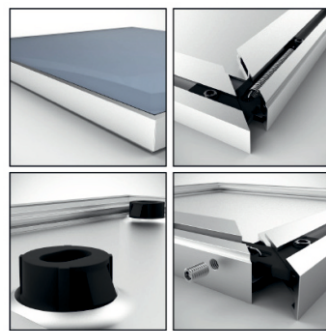

FOR NON-STANDARD SOLUTIONS - PRICE ON REQUEST e-mail: support@wmt | phone: +371 26 596 474

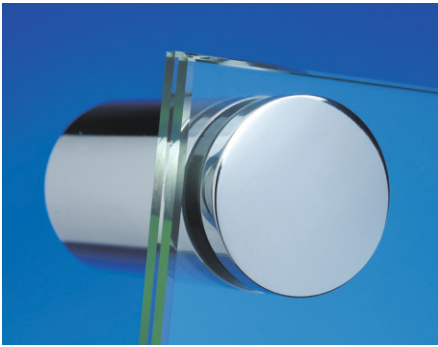

Art. 22320018 Mix chrome

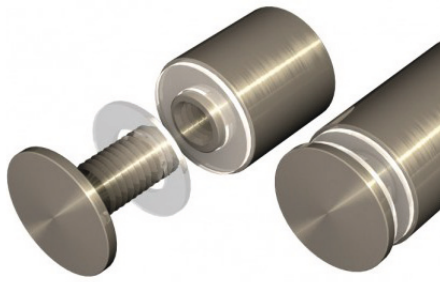

Art. 22310082 Madrid



Art. 22321041 Ring kombo

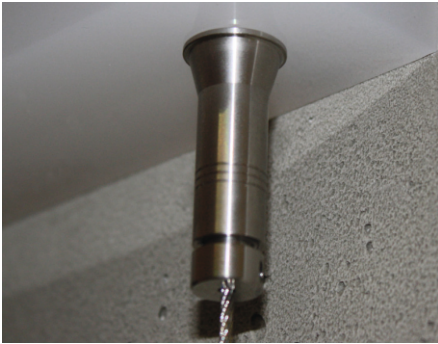

Art. 22310021 Paris



Art. 22321020 Unico



Art. 22310029 Bukarest

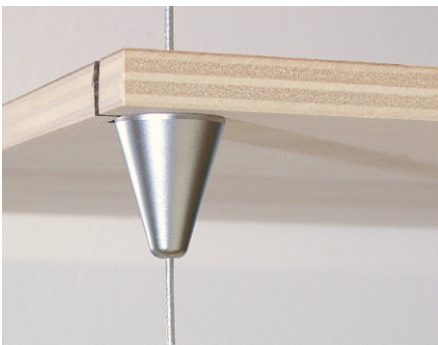

Art. 22321066 Pyramid

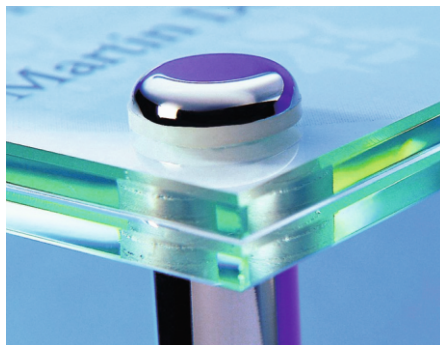

Art. 22321071 Midi chrome



Art. 22321091 Rosett



Art. 22321060 Plusmini



Art. 22321055 Punto



Art. 22320043 Perla



Art. 22310013 Budapest

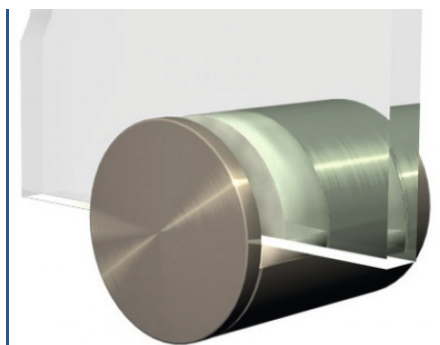

Art. 22310019 Lubeck



Art. 22310040 Vinox wall

# DO YOU NEED DOOR SIGNS?

# APG



**Choose a style  
Choose a color**

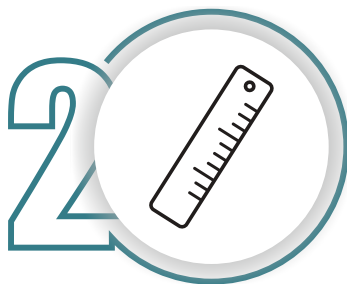

**Specify the size in  
millimeters (mm)**

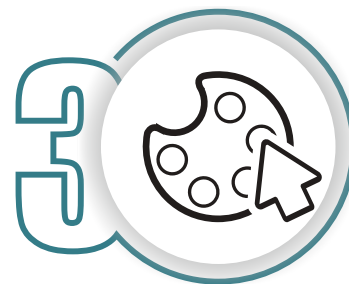

**Choose the color  
of end-caps**



**Place an order  
support@wmt.lv**



**Confirm the delivery address  
and courier**



**Receive an order  
confirmation**



**Receive an Invoice  
and pay it**



**Within 2 days you receive  
the goods at your address**



**BE HAPPY!**



**WMT BALTIC**  
A. Deglava 166B, Riga, Latvia  
Tel.: +371 67 800 830, +371 26 596 474  
e-mail: support@wmt.lv  
www.apg.uzlex.eu | www.adv24.lv

**WMT Vilnius UAB**  
Žirnių g. 28A, Vilnius, LT-02120, Lietuva  
Tel.: +370 640 39964, +370 5 2485608, +370 655 62119  
El.paštas: info@adv24.lt  
www.apg.uzlex.eu | www.adv24.lt

## CLICK profile solutions



WMT BALTIC  
A. Deglava 166B, Riga, Latvia  
Tel.: +371 67 800 830, +371 26 596 474  
e-mail: support@wmt.lv  
www.apg.uzlex.eu | www.adv24.lv

## 2.1. Clic profile frames

### CLIC FRAME 25 MM *Best product*

Aluminium click profile frame for frequent and quick poster change. The frame is designed for graphics of small and medium sizes. Special plastic protects your print or poster from fading.

Art.	Colour	DIN/size
21670401	Silver matt	A4/ 210*297 mm
21670402	Silver matt	A3/297*420 mm
21670403	Silver matt	A2/420*594 mm
21670404	Silver matt	A1/594*841mm
21670405	Silver matt	B2/ 500*700 mm

Colours:



silver matt



### CLIC FRAME 32 MM *Best product*

Aluminium click profile frame for frequent and quick poster change. The frame is designed for graphics of small and medium sizes. Special plastic protects your print or poster from fading.

Art.	Colour	DIN/size
21670421	Silver matt	A0/ 841*1189 mm
21670422	Silver matt	B1/700*1000 mm
21670423	Silver matt	B0/1000*1400 mm

Colours:



silver matt

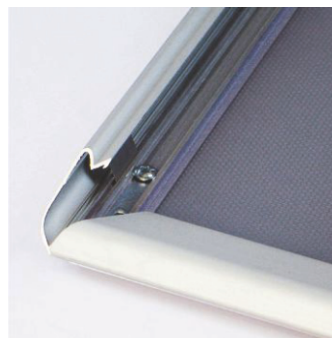



## Poster mounting systems

2.2.

### POSTERSNAPPER

Set of 2 aluminum Snap profiles 25mm wide, silver anodized finish with black plastic end caps and sliding hooks. The snap profiles have integrated black foam rubber strips to prevent the posters from slipping.

Art.	Product name	Size
21520301	Postersnapper PP21	210 mm
21520305	Postersnapper PP70	700 mm
21520306	Postersnapper PP100	1000 mm
21520307	Postersnapper PP60	600 mm

Colours:  silver matt

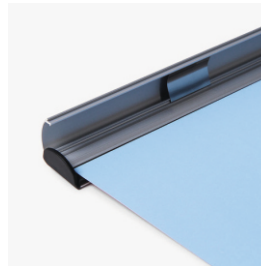
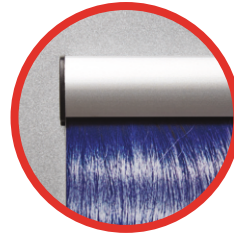
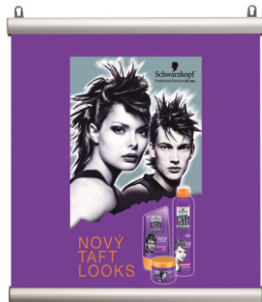

## Banner mounting systems

2.3.

### POSTERELIPS

Set of 2 aluminum profiles, silver anodized finish with gray plastic end caps and sliding hooks. Used for medium or large PVC banner or textile print.

Art.	Product name	Size
21604701	PosterElips PE60	600 mm
21604702	PosterElips PE70	700 mm
21604703	PosterElips PE100	1000 mm
21604704	PosterElips PE120	1200 mm
21604705	PosterElips PE150	1500 mm
21604706	PosterElips PE200	2000 mm
21604707	PosterElips PE300	3000 mm

Colours:  silver matt

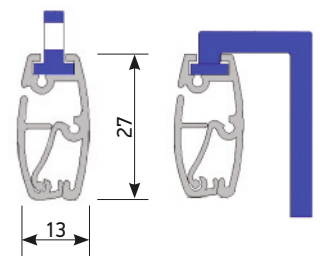
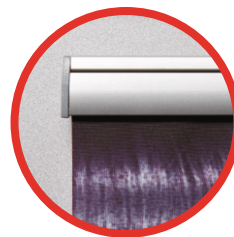
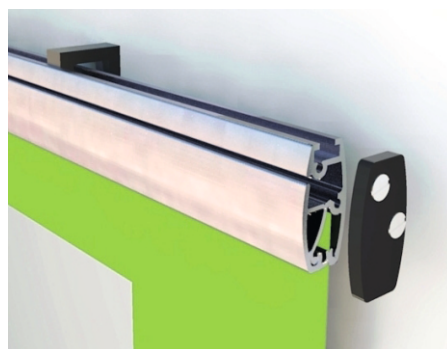
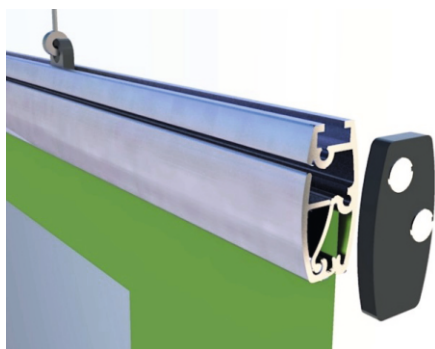

# Lockable frame

The four sides of the lockable frame can be opened sequentially by removing the security screw.

This system ensures your poster is never accessed by unauthorized people which makes it extremely suitable for public areas. The allen key for unlocking the profiles and screws and plugs for wall mounting are included.

Profiles: 32mm Silver Anodised  
Corners: 45°

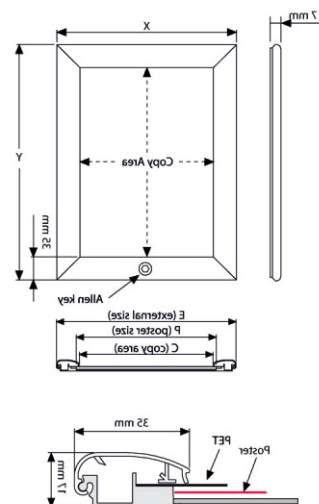
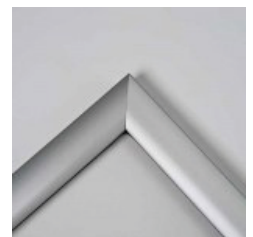

## AVAILABLE SIZES

- One sided
- A3, A2, A1, A0, B1, B2

2.5.



Suitable for outdoor use. Available in every poster size.

The frame has water drainage holes and is weatherproof (IP55 approved). Screws and plugs for wall mounting are included.

Profiles: 25mm Silver Anodized

Corners: 45°

# Weatherproof frame

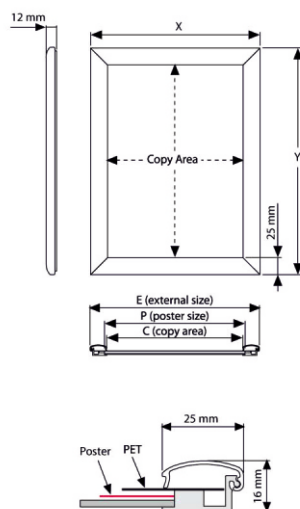

## AVAILABLE SIZES

One sided

A4, A3, A2, A1, B1, B2

## 2.6. Outdoor A-board stand with *Clic* frame



Stable double-sided outdoor stand made of aluminium profiles. Base is made of 33mm aluminium profile with anti-corrosion coating, angle between *Clic* frame profiles is 45°. The stand can be used in any weather conditions due to the holes in the profiles base for water and condensate diversion. The A-board stand also includes a PVC cover that protects your posters from damage and fading.

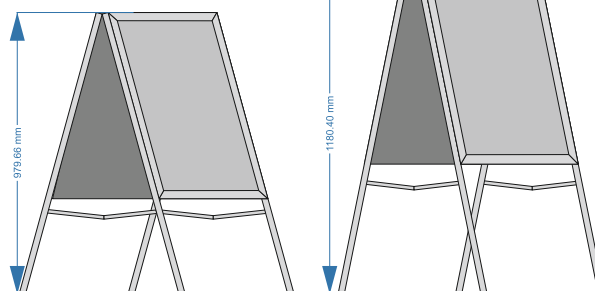
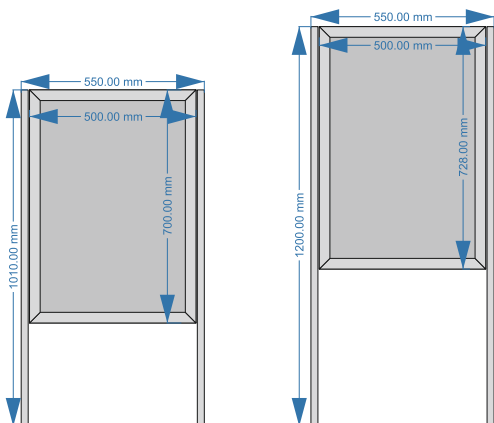

### Format (poster size)

A1 B1

Vertical

Horizontal

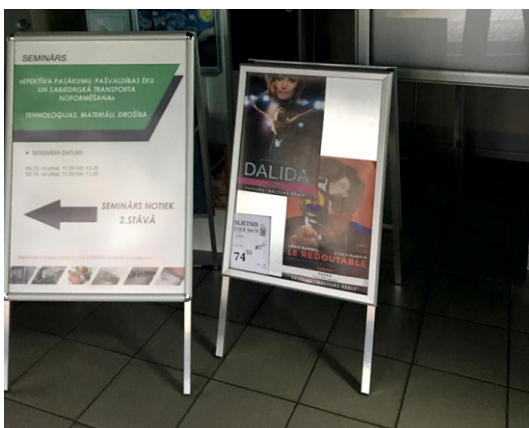

**SEND US A REQUEST AND WE WILL MAKE AN OFFER A.S.A.P.**

# Advertising Click Stand

2.7.

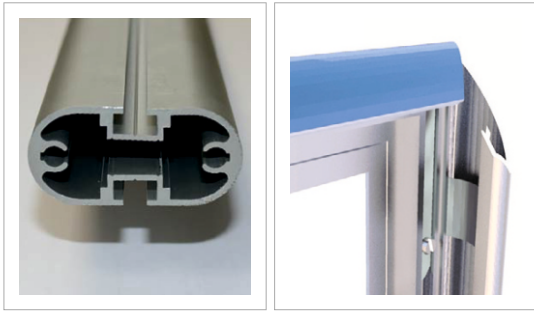

- One-sided or double-sided advertising stand. An advertising poster can be placed horizontally or vertically.
- Anodised aluminium *Click* frame 25mm (A4, A3) or 32mm (A2, A1) with snap mechanism for frequent and quick placement and change of posters and other printed products.
- Anodised aluminium pole 50mm x 25mm and base
- 330mm x 250mm (A4, A3, A2) D= 450mm (A1).
- For Indoor, Outdoor use.

Booklet holder can be placed on all stands.

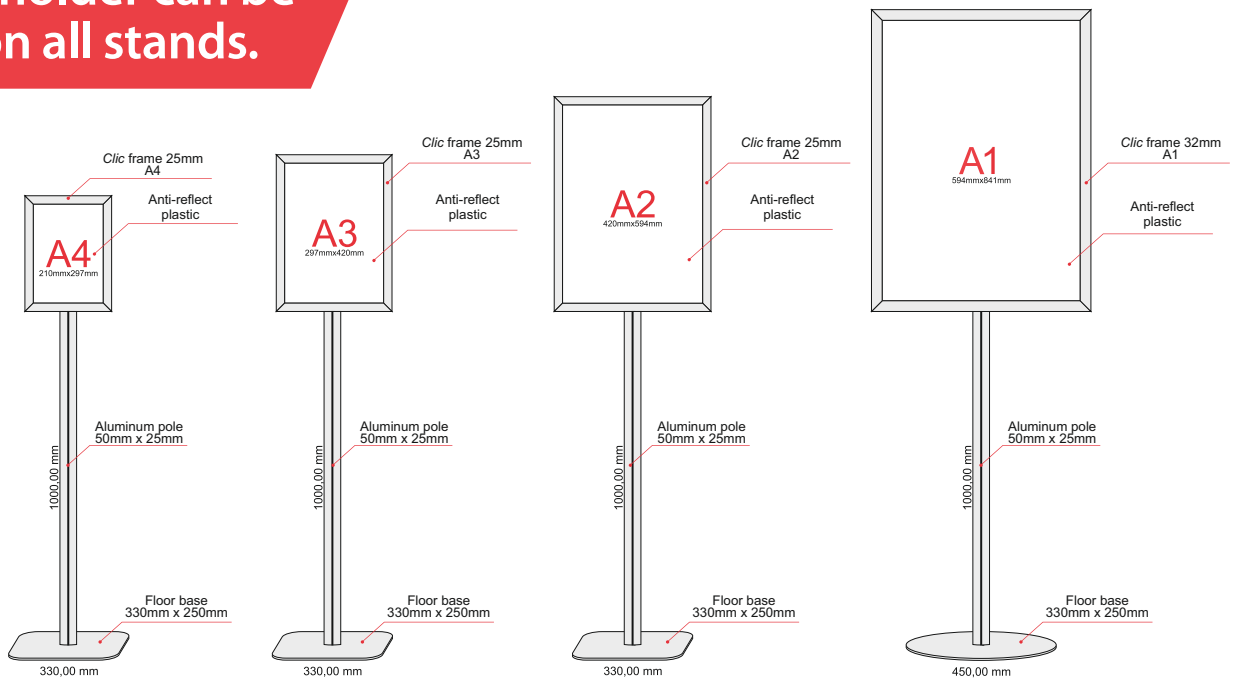

One-sided

Format

Double-sided

A4 A3

A1 B1

Vertical

Horizontal

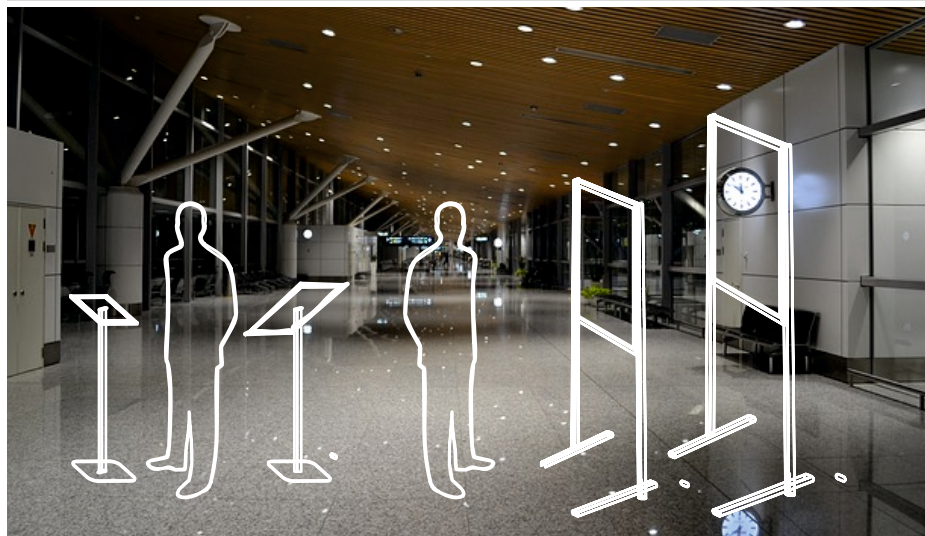

SEND US A REQUEST AND WE WILL MAKE AN OFFER A.S.A.P.

# Menuboard

Our menuboard can be displayed in strategic places. The decorative menuboard is available in landscape or portrait, in A4 or A3 format. The height of the post is 1000mm for the A4 format and 1200mm for the A3 format. Our flexible menuboard is multifunctional. The angle (0 - 90°) of the frame and height of the post are adjustable.

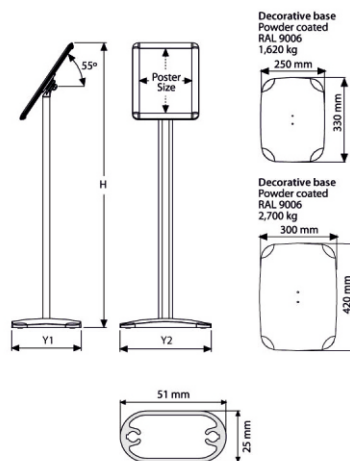

## AVAILABLE SIZES

One sided  
A4, A3

# INFO Clic Stand

2.9.

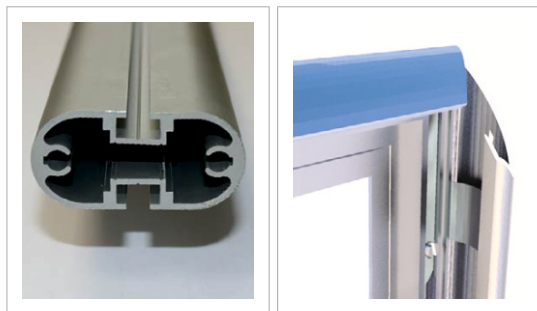

- One-sided or double-sided (A1, B1) advertising stand. An advertising poster can be placed horizontally or vertically.
- Anodised aluminium *Clic* frame 25mm (A4, A3) or 32mm (A1, B1) with snap mechanism for frequent and quick placement and change of posters and other printed products.
- Anodised aluminium pole 50mm x 25mm and base 330mm x 250mm (A4, A3) or two anodised aluminium legs (A1, B1).
- For Indoor, Outdoor use.

Booklet holder can be placed on all stands.

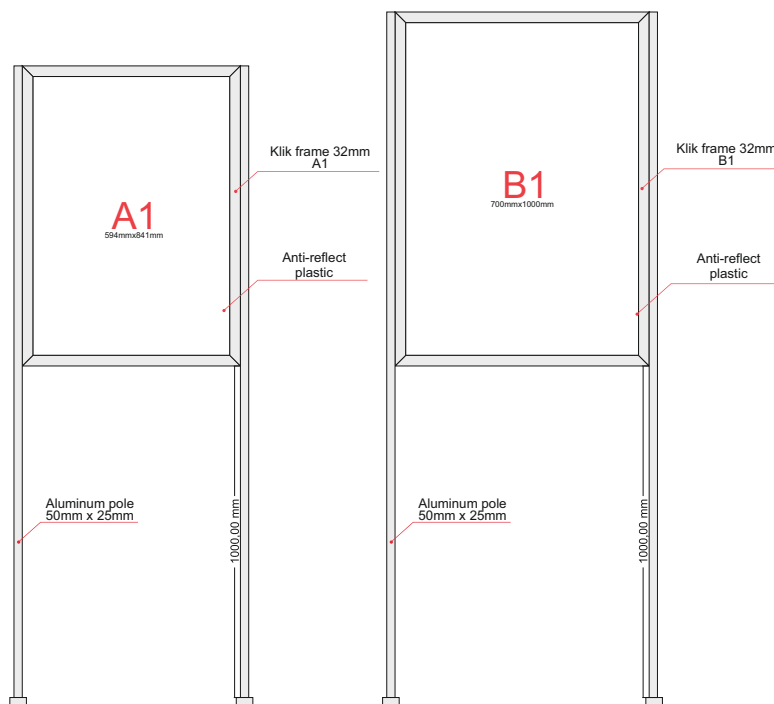
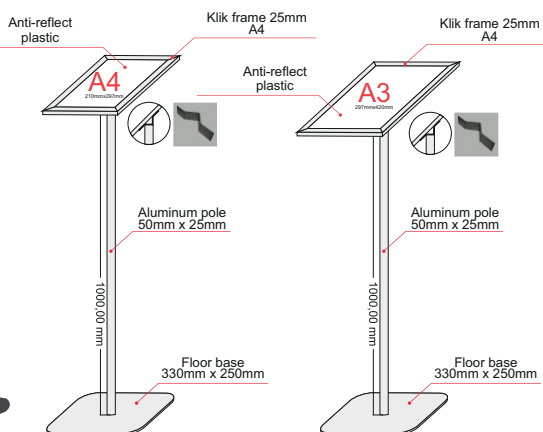

One-sided

Format

A4 A3

A1 B1

Double-sided  
(A1, B1)

Vertical

Horizontal

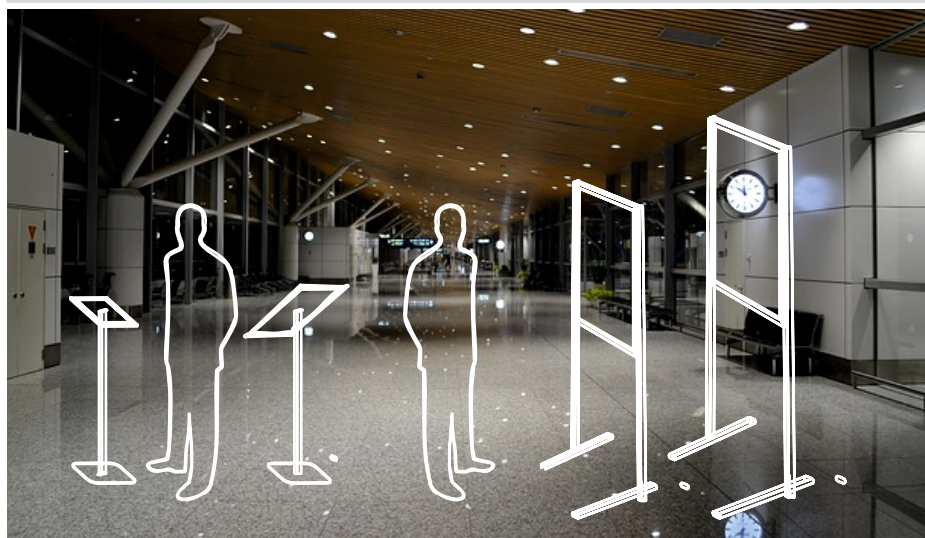

SEND US A REQUEST AND WE WILL MAKE AN OFFER A.S.A.P.

# LED FRAMES

## TEXTILE LED FRAMES



WMT BALTIC  
A. Deglava 166B, Riga, Latvia  
Tel.: +371 67 800 830, +371 26 596 474  
e-mail: support@wmt.lv  
www.apg.uzlex.eu | www.adv24.lv



## Ultrathin Light LED Frames

### MAGNETIC PANEL 12 MM *Best product*

Ultra-thin 12mm aluminum profile frame with LED lighting and a magnetic system for frequent and quick change of poster. Frame is intended for small and medium sized graphics. Easy poster change by lifting off the magnetic front panel. Silver finish with black and gray front border - other colors on request. Supplied with a rubber suction cup for easy poster replacement. Special plastic protects your print or poster from fading.



Colours:  grey  black

Art.	Colour	DIN/size
21870001	One-sided Panel/Grey	A4/ 210*297 mm
21870002	One-sided Panel/Grey	A3/297*420 mm
21870003	One-sided Panel/Grey	A2/420*594 mm
21870004	One-sided Panel/Grey	A1/594*841mm
21870005	One-sided Panel/Grey	B2/ 500*700 mm
21870011	One-sided Panel/Black	A4/ 210*297 mm
21870012	One-sided Panel/Black	A3/297*420 mm
21870013	One-sided Panel/Black	A2/420*594 mm
21870014	One-sided Panel/Black	A1/594*841mm
21870015	One-sided Panel/Black	B2/ 500*700 mm



### MAGNETIC PANEL 16 *Best product*

Aluminum magnetic profile system for ultrathin double-sided flat light panels up to A0 size with front board 8 mm LED lighting. As a faceplate is used transparent PET-plastic 1,5-2 mm (the thickness of the plastic depends on the size of a panel). Plastic is fixed in the panel with special magnetic tapes (Type A + Type B). To cover magnetic tapes along the perimeter of the faceplate should be made «edging frame» (recommended width – 30 mm). «Edging frame» can be painted or made of vinyl film. The faceplate can be removed with a special suction cup.



Art.	Product name	DIN/Size
21870011	Double-sided panel	A4/210*297mm
21870012	Double-sided panel	A3/297*420mm
21870013	Double-sided panel	A2/420*594mm
21870014	Double-sided panel	A1/594*841mm
21870015	Double-sided panel	B2/500*700mm
21870016	Double-sided panel	B1/700*1000mm

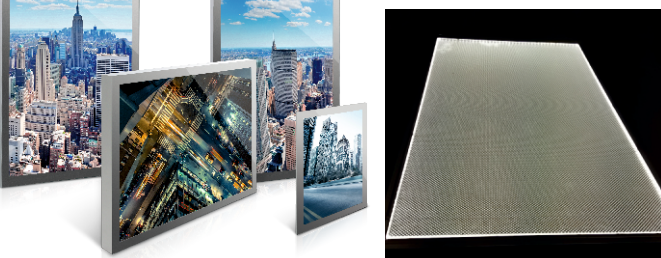

Colours:  grey  black



### 3.2. Light LED frames

#### LIGHT LED *Best product*

Ultra-thin LED light box (one-sided 23mm, double-sided 30mm) with Click system for easy poster replacement. Structured 8 mm panel with special coating guarantees improved quality and good lighting.

Art.	Product name	DIN/size
21850101	One-sided LED box LightLEDA4	A4/ 210*297 mm
21850102	One-sided LED box LightLEDA3	A3/297*420 mm
21850103	One-sided LED box LightLEDA2	A2/420*594 mm
21850104	One-sided LED box LightLEDA1	A1/594*841mm
21850105	One-sided LED box LightLEDA0	A0/ 841*1189 mm
21850106	One-sided LED box LightLED50x70	B2/ 500*700 mm
21850107	One-sided LED box LightLED70x100	B1/ 700*1000 mm
21850111	Double-sided LED box LightLEDA4D	A4/ 210*297 mm
21850112	Double-sided LED box LightLEDA3D	A3/297*420 mm
21850113	Double-sided LED box LightLEDA2D	A2/420*594 mm
21850114	Double-sided LED box LightLEDA1D	A1/594*841mm
21850115	Double-sided LED box LightLEDA0D	A0/ 841*1189 mm
21850116	Double-sided LED box LightLED50x70D	B2/ 500*700 mm
21560117	Double-sided LED box LightLED70x100D	B1/ 700*1000 mm

Colours:  silver matt



### SUSPENSION SYSTEMS



**Suspension Clip Conical**  
Cable thickness - max 1,5mm  
Max weight - 20kg

**APC Cable (with 4.5mm ball nipple)**  
Cable thickness - max 1,5mm  
Max weight - 16kg



**Suspension Clip Cylindrical**  
Cable thickness - max 1,5mm  
Max weight - 20kg

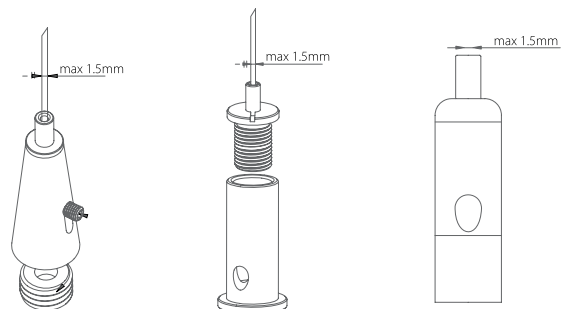

**Suspension Clip Eco**  
Cable thickness - max 1,5mm  
Max weight - 20kg

## Large Magnetic Light Box

3.3.

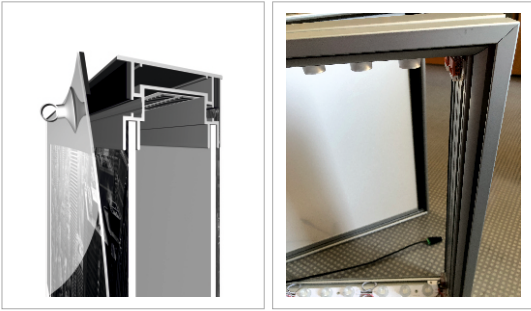

Elegant indoor lightbox with a depth of only 75mm (single-sided) or 100mm (double-sided). The hinging frame on top makes maintenance and a quick change of the acrylic panels and/or graphics extremely easy.

The hinging frame comes in 2 versions. One has the typical I-Sign look with the thin edge. The other one has an edge of 12,5mm which allows acrylic panels to be fully illuminated.

The perfect lightbox for airports, metro stations, garages.

**NEW**

**MAGNETIC 75 – one sided**  
**MAGNETIC 100 – double sided**

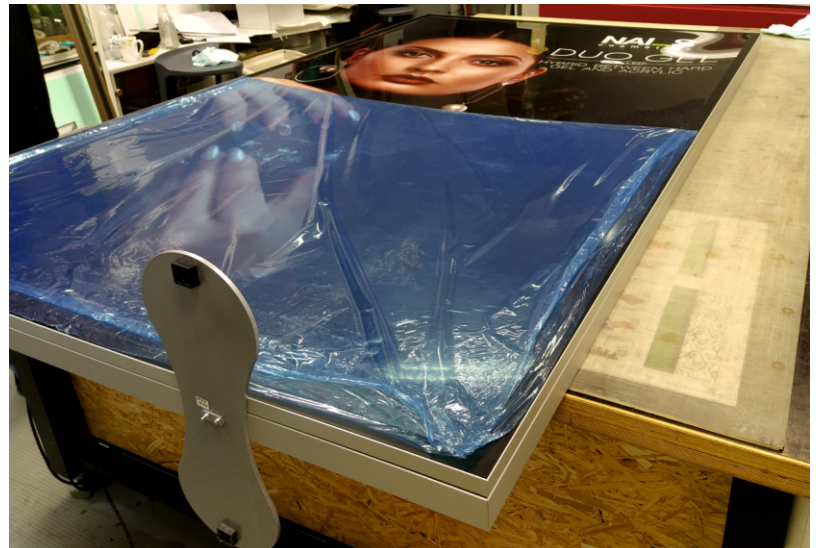

**SINGLE SIDED - FRAME I**  
**SIMPLE FACE - CADRE I**

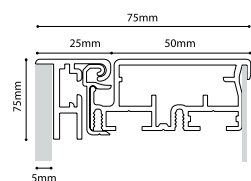

**SINGLE SIDED - FRAME N**  
**SIMPLE FACE - CADRE N**

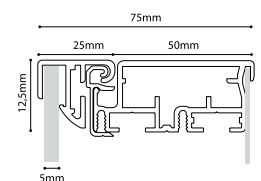

**DOUBLE SIDED - FRAME I**  
**DOUBLE FACE - CADRE I**

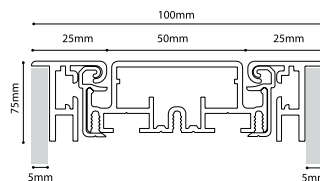

**DOUBLE SIDED - FRAME N**  
**DOUBLE FACE - CADRE N**

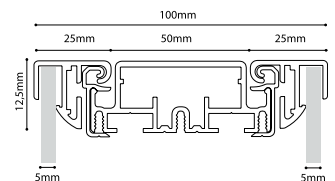

**SEND US A REQUEST AND  
WE WILL MAKE AN OFFER A.S.A.P.**

### 3.4. SOLED

SOLED is an architectural sign application where a LED strip is integrated into the profiles that ensures the light is introduced in a glass or acrylic sheet from the side. This ensures that the image on the front of the sheet is lit up. The image can easily be added to the sheet using a film or it can be engraved into the sheet.

SOLED is a modular system where the customer can choose between a round, curved or square profile and where the signs can be wall mounted, suspended or flag mounted.

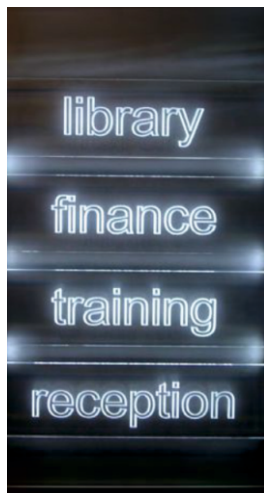
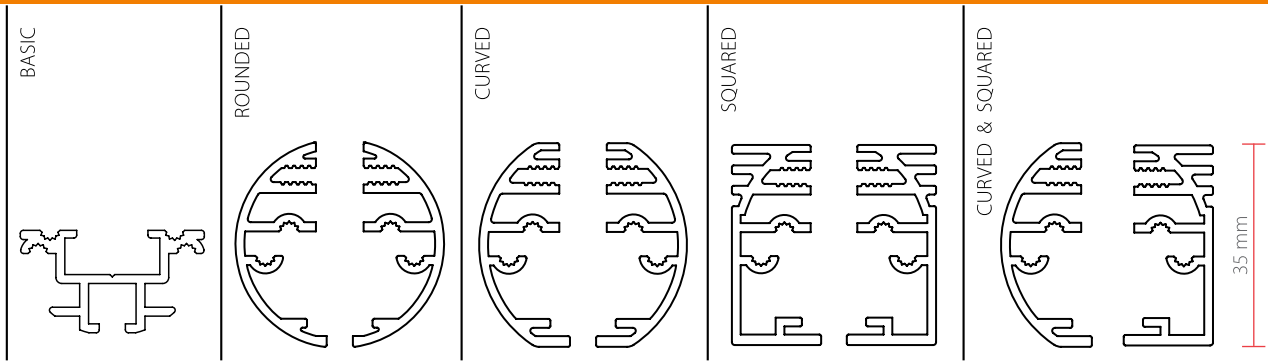

Art.	Product name	Size
21880100	SOLED curved <i>flag</i>	200X200mm
21880101	SOLED curved <i>flag</i>	300X200mm
21880103	SOLED curved <i>up</i>	1000x300mm
21880102	SOLED curved <i>up</i>	500X300mm
21880100	SOLED square <i>wall</i>	1000X500mm
21880101	SOLED square <i>wall</i>	500X300mm
21880103	SOLED square <i>wall</i>	700x300mm
21880102	SOLED square <i>wall</i>	700X500mm

Colours: silver matt

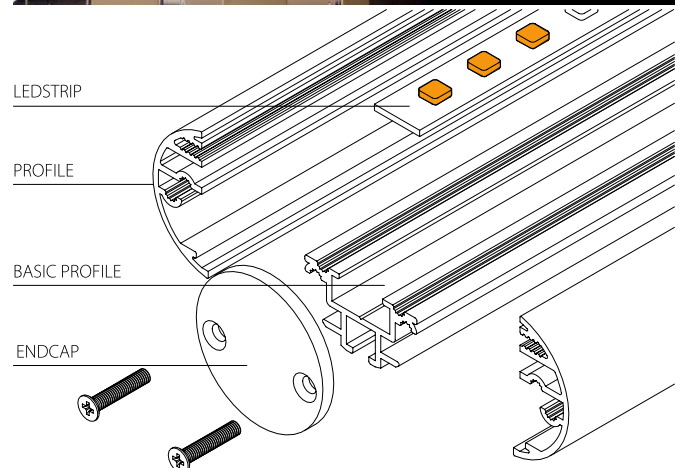

**3.5.**

Led Thinlite is a thin illuminated display of the next generation combining all the benefits LED lighting has to offer.

Featured with a depth of 19mm, a long lifetime and a low power consumption our Led Thinlites enable you to advertise in space limited areas while paying for themselves in energy and maintenance savings. All Led Thinlites have a convenient snap frame mechanism with hidden springs and elegant rounded safety corners. All units have passed the CE/UL Pat test and come with the required quality certificates.

Profiles: 25mm Silver anodized

Corners: Rounded safety corners

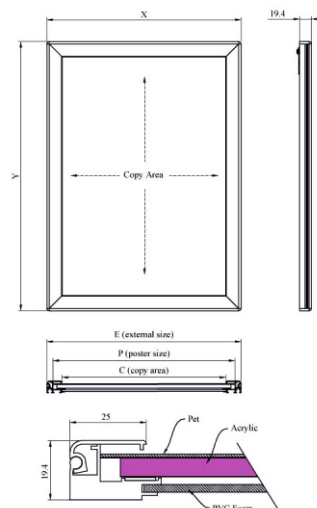
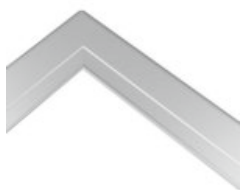
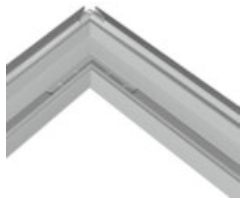
**AVAILABLE SIZES**

ONE SIDED

A4, A3, A2, A1, A0, B1, B2

DOUBLE SIDED

**LED  
Thinlite**

### 3.6. Textile tension frames

#### TEXFRAME 16 MM

Textile tension frame of 16mm anodized aluminum profile, intended for small-sized textile graphics tension. Used for wall mounting.

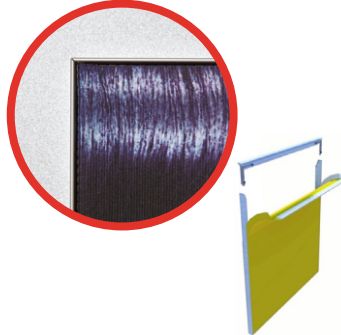

Art.	Colours	DIN/size
21602113	Silver matt	A3/297*420 mm
21602114	Silver matt	A2/420*594 mm
21602115	Silver matt	A1/594*841 mm
21602116	Silver matt	500*1000 mm

Colours:  silver matt

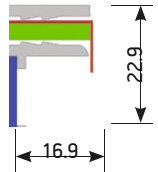

#### TEXFRAME 22 MM

Textile tension frame of 22 mm anodized aluminum profile, intended for medium-sized textile graphics tension. Used for wall mounting.



Art.	Colours	DIN/size
21602213	Silver matt	A0/841*1189 mm
21602214	Silver matt	B1/700*1000 mm
21602215	Silver matt	1000*1000 mm
21602216	Silver matt	1000*1500 mm
21602217	Silver matt	1000*2000 mm

Colours:  silver matt

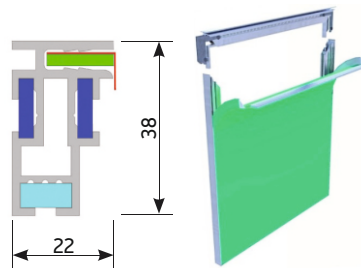

#### TEXFRAME 45 MM

Double-sided textile tension frame of 45 mm anodized aluminum profile, used for large-sized textile tension systems. Double-sided frame can be used as interzonal division wall.



Art.	Colour	DIN/size
21602313	Silver matt	1000*1500 mm
21602314	Silver matt	1000*2000 mm
21602315	Silver matt	2000*1500 mm
21602316	Silver matt	2000*2000 mm

Colours:  silver matt

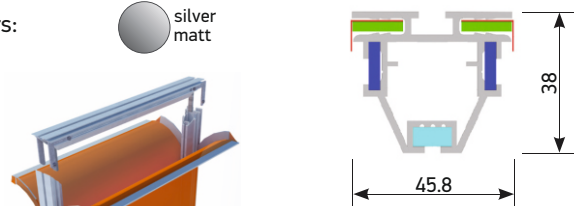

# Light Tex frames

## TEXBOX 50MM

One-sided light box with textile tensioning frame of 50 mm anodized aluminum profile.  
For indoor application.



Art.	Product name	DIN/size
21602401	One-sided textile box LightTexA0	A0/841*1189 mm
21602402	One-sided textile box LightTexB1	B1/700*1000 mm
21602403	One-sided textile box LightTex1000X1000	1000*1000 mm
21602404	One-sided textile box LightTex1000X1500	1000*1500 mm
21602405	One-sided textile box LightTex1000X2000	1000*2000 mm

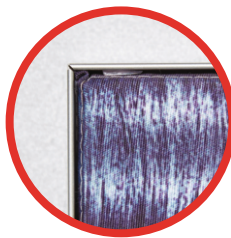

Colours:  silver matt



## TEX BOX 80MM, TEX BOX 100 *Best product*

Textile frames are the solution for the quick replacement and easy exchange of printed textile fabrics. The image is printed on a textile fabric and a silicon beading is added around it. It is simply pressed into the profile that ensures that the slightly stretchable fabric can be tensed perfectly.

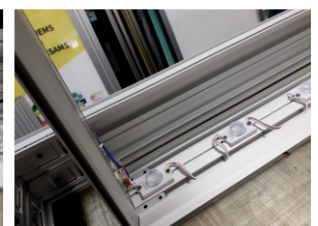
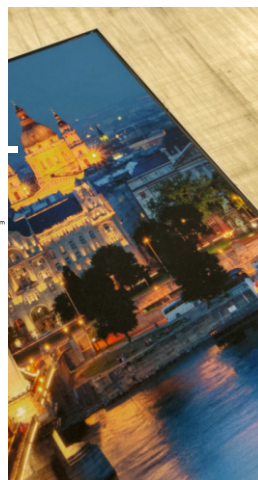
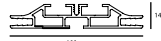
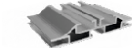
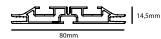

Art.	Product name	DIN/size
21602411	Double-sided textile box LightTexA0	A0/ 894*1189 mm
21602412	Double-sided textile box LightTex1000X1500	1000*1500 mm
21602413	Double-sided textile box LightTex2000X1500	2000*1500 mm
21602414	Double-sided textile box LightTex2000X2000	2000*2000 mm

Colours:  silver matt

## PROFILE ACCESSORIES



TEXCIRCLE

ø 450 x 6mm

TEXHOOP

ø 450 x 6mm

TEXBASE

450 x 300 x 6mm

TEXFILLET

500 x 180 x 6mm

# OUTDOOR SOLUTIONS



Tirdzniecības vietas  
Lidostas  
Viesnīcas  
Ofisi, darba telpas  
Medicīnas iestādes  
Mācību iestādes



# Windows Box system

**4.1.**



Aluminum showcase profile system 30 or 70 mm thick for one-sided light boxes with doors. System includes the ability to install into the door special rubbertapes for door glass and doorlock, that allows to use the box outdoor.

Art.	Product name	DIN/size
21860170	Windows Box system indoor/outdoor	4xA4
21860169	Windows Box system indoor/outdoor	6xA4
21860171	Windows Box system indoor/outdoor	9xA4
21860172	Windows Box system indoor/outdoor	12xA4
21860173	Windows Box system indoor/outdoor	16xA4

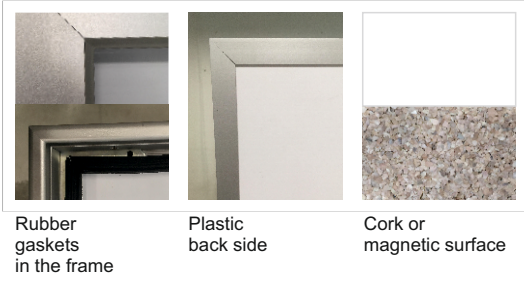
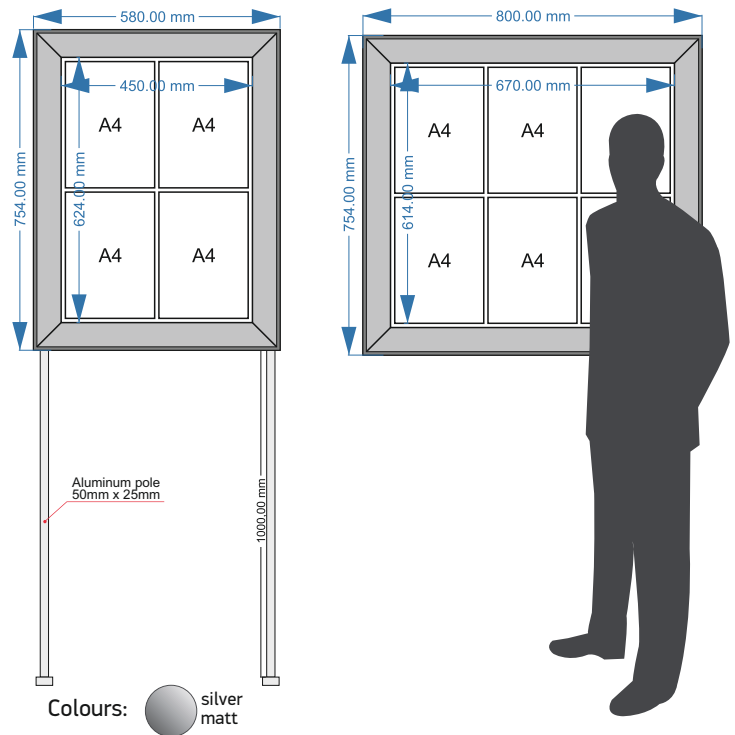
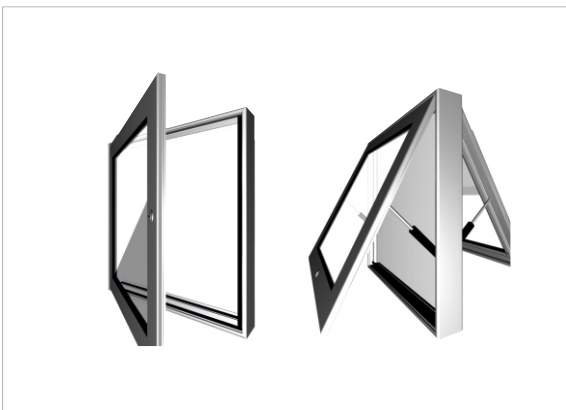

<b>Format</b>	<b>4xA4</b>	<b>6xA4</b>	<b>9xA4</b>	<b>12xA4</b>
	450x624	670x624	670x931	890x931

**SEND US A REQUEST AND WE WILL MAKE AN OFFER A.S.A.P.**

*We produce individual designs*

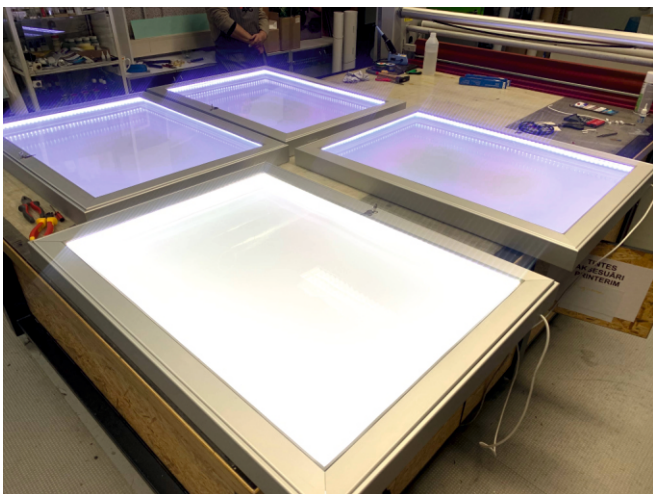

## 4.2. Advertising Construction with lightning



- Total size 1000x2500 or 1000x2000, tringular construction 1 piece (from 3 or 2 parts). Base - steel plate, for installation on anchor screws, 1 piece.
- The visible part of the construction is made of metal sheet, silver color RAL 9006, connected by cylidrical profiles (anodized aluminum D=60mm).
- Interior parts of construction: lower part, middle part, top part or lower part and middle part.
- You can order with or without LED lighting.

Internal parts of the construction:

**Lower part :**

1. Metal sheet;

**Medium part:** - lockable glass case (max size 841x1189mm (A0)):

1. Backside wall is made of metal;
2. Aluminium profile construction (anodised aluminium);
3. Front - monopolycarbonate glass (shockproof material).

**Top part:**

1. Metal sheet;

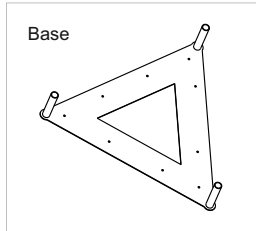
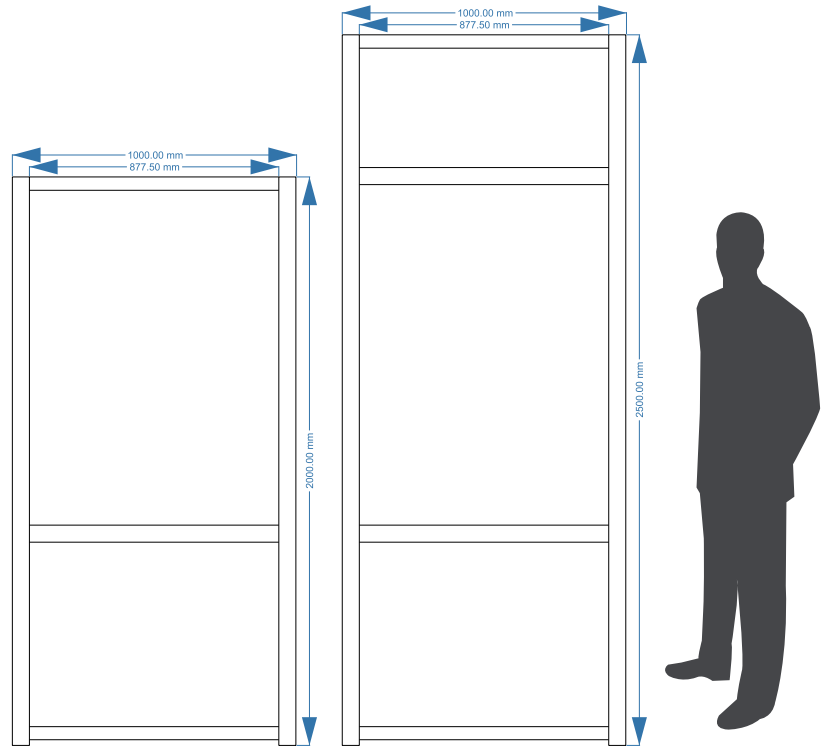

It is possible to install the LED lighting of all parts.

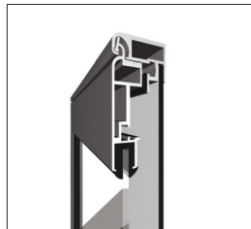

SEND US A REQUEST AND WE WILL MAKE AN OFFER A.S.A.P.

We produce individual designs

**PYLON STANDBOX 20** 

Aluminum profile system for the production of small double-sided pylons. Recommended for indoor advertising.

4.3.

Art.	Product name
21604701	Pylon StandBox 20, size 1200*550mm
21604702	Pylon StandBox 20, size 1500*550mm
21604703	Pylon StandBox 20, size 2000*550mm
21604711	Pylon StandBox 20, size 1200*800mm
21604712	Pylon StandBox 20, size 1500*800mm
21604713	Pylon StandBox 20, size 2000*800mm

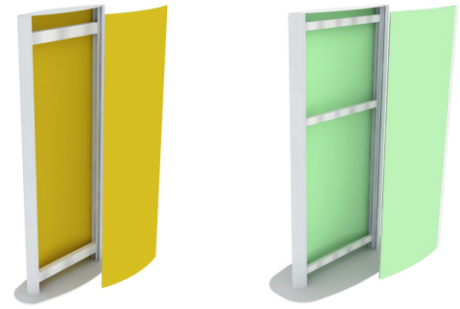

**PYLON STANDBOX 40**

Aluminum profile system for the production of medium double-sided pylons. Recommended for indoor and outdoor advertising.

Art.	Product name
21604722	Pylon StandBox 40, size 1500*800mm
21604723	Pylon StandBox 40, size 2000*800mm

Colours:   
silver  
matt



**MODULE PLUS OUTDOOR (on request)**

4.4.

Module Plus outdoor is the complete external directional sign system. As well as being both modular and interchangeable, Module Plus is extremely robust. The system consists of three post options - circular, elliptical and square - together with a range of panels available at 46 mm, 60 mm, 100 mm, 150 mm and 250 mm high. The use of panel supports and 8 mm or 4 mm (reduction profile) thick foam PVC allows the customer to create a custom panel of any depth. Accessories include a range of post caps, post feet and luminaires. Post and text panels can be supplied as components or cut to size lengths.

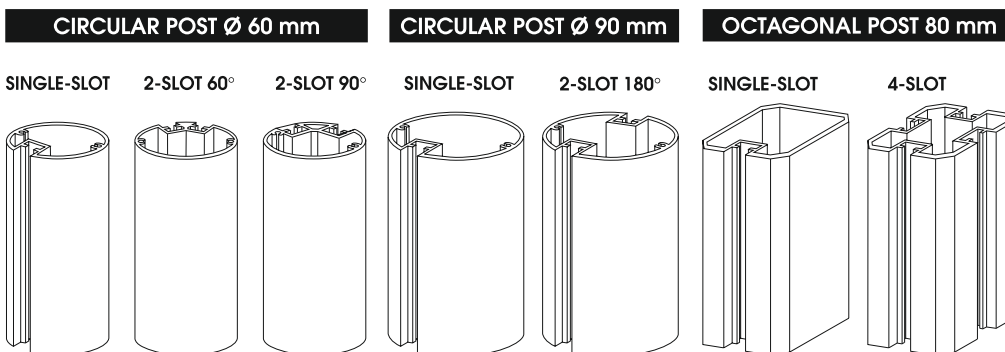
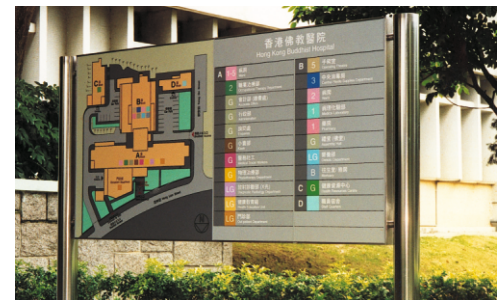
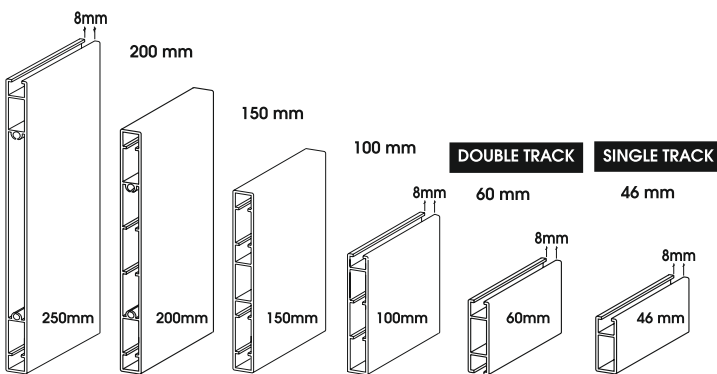

# wmt.baltic

## MORE POSSIBILITIES IN ONE PLACE



SLICING



CONVERTING



PLASTIC CUTTING



DIAMOND POLISHING



UV PRINTING



VACUUM FORMING



DIGITAL CUTTING



LASER CUTTING



MILLING

